

Data Communications and Computer Networks

Computer Fundamentals

Professor Dr. Md. Ismail Jabiullah
Department of CSE
Daffodil International University

Learning Objectives

In this chapter you will learn about:

- Basic elements of a communication system
- Techniques, channels, and devices used to transmit data between distant locations
- Types of computer networks
- Communication protocols and their use in computer networks
- Internetworking tools and their use in building large computer networks
- Characteristics and advantages of distributed data processing

Basic Elements of a Communication System

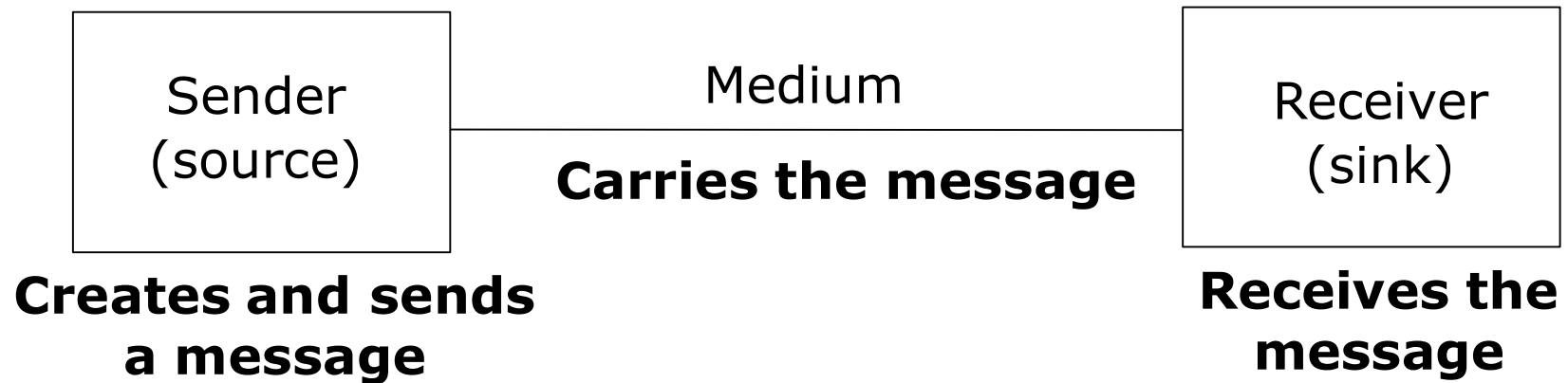

Data Transmission Modes

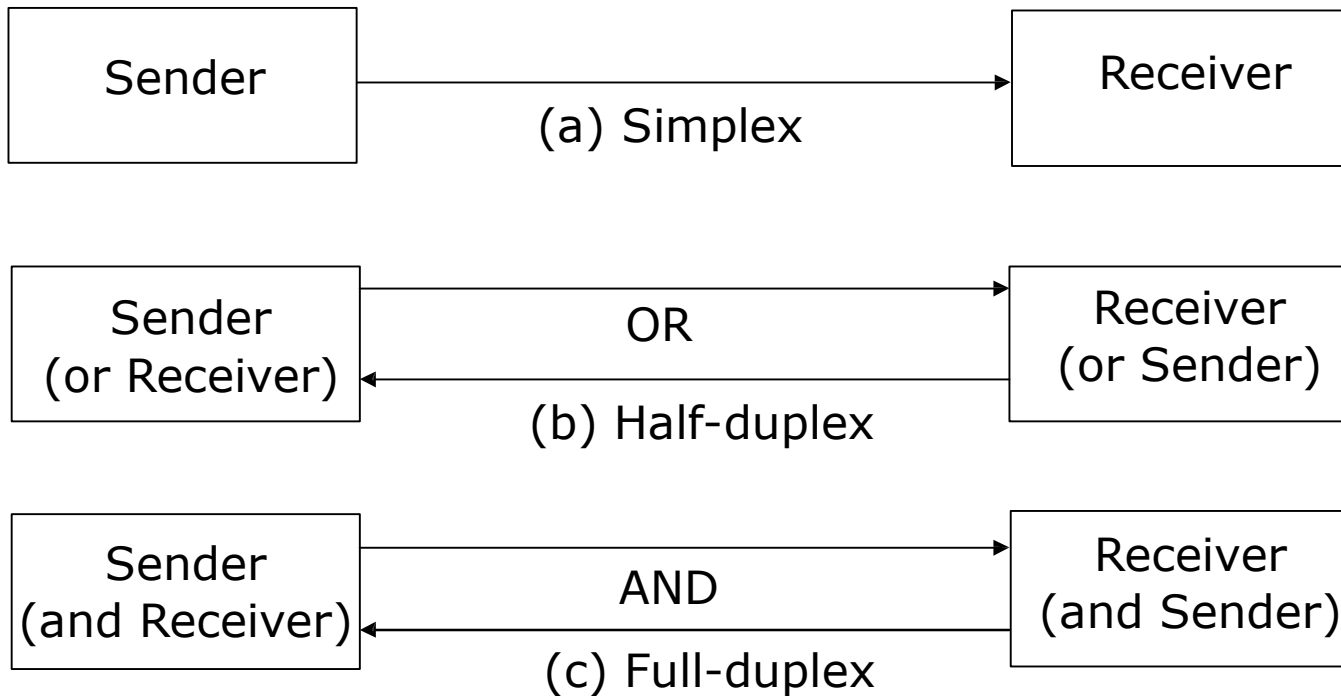

Data Transmission Speed

- **Bandwidth:** Range of frequencies available for data transmission. It refers to data transmission rate. Higher the bandwidth, the more data it can transmit
- **Baud:** Unit of measurement of data transfer rate. Measured in bits per second (bps)

Data Transmission Speed Category

- **Narrowband:** Sub-voice grade channels in range from 45 to 300 baud. Mainly used for telegraph lines and low-speed terminals
- **Voiceband:** Voice grade channels with speed up to 9600 baud. Mainly used for ordinary telephone voice communication and slow I/O devices
- **Broadband:** High speed channels with speed up to 1 million baud or more. Mainly used for high-speed computer-to-computer communication or for simultaneous transmission of data

Data Transmission Media

The most commonly used ones are:

- Twisted-pair wire (UTP cable)
- Coaxial cable
- Microwave system
- Communications satellite
- Optical fibers

Unshielded Twisted-Pair (UTP) Cable



Coaxial Cable

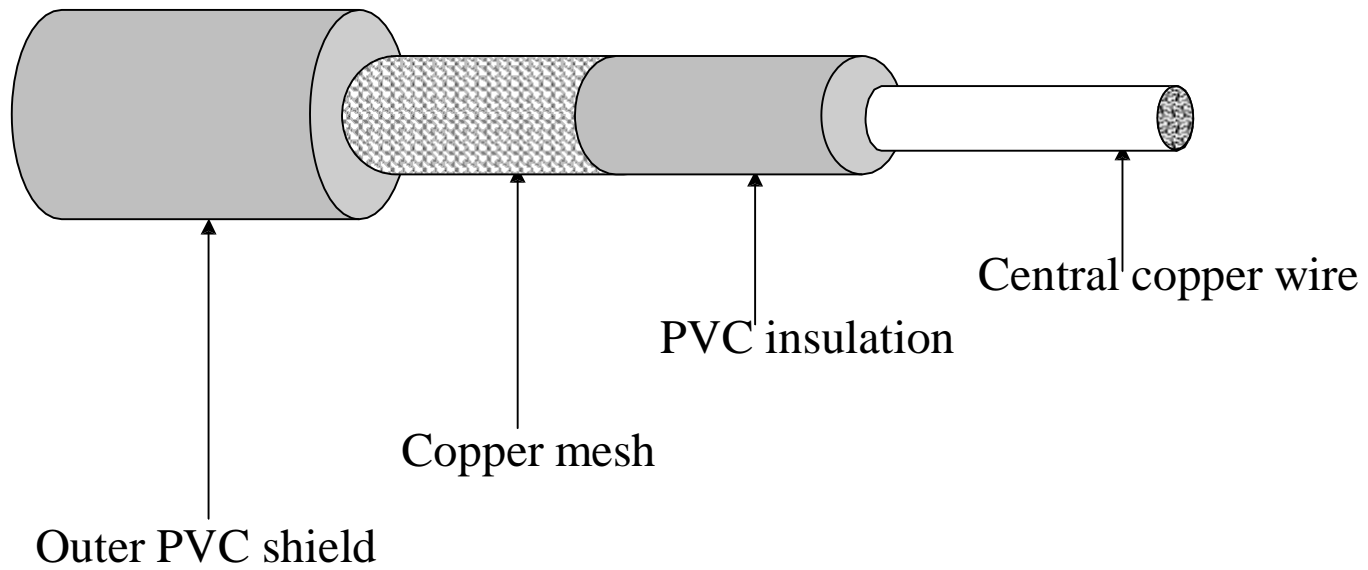

Microwave Communication System

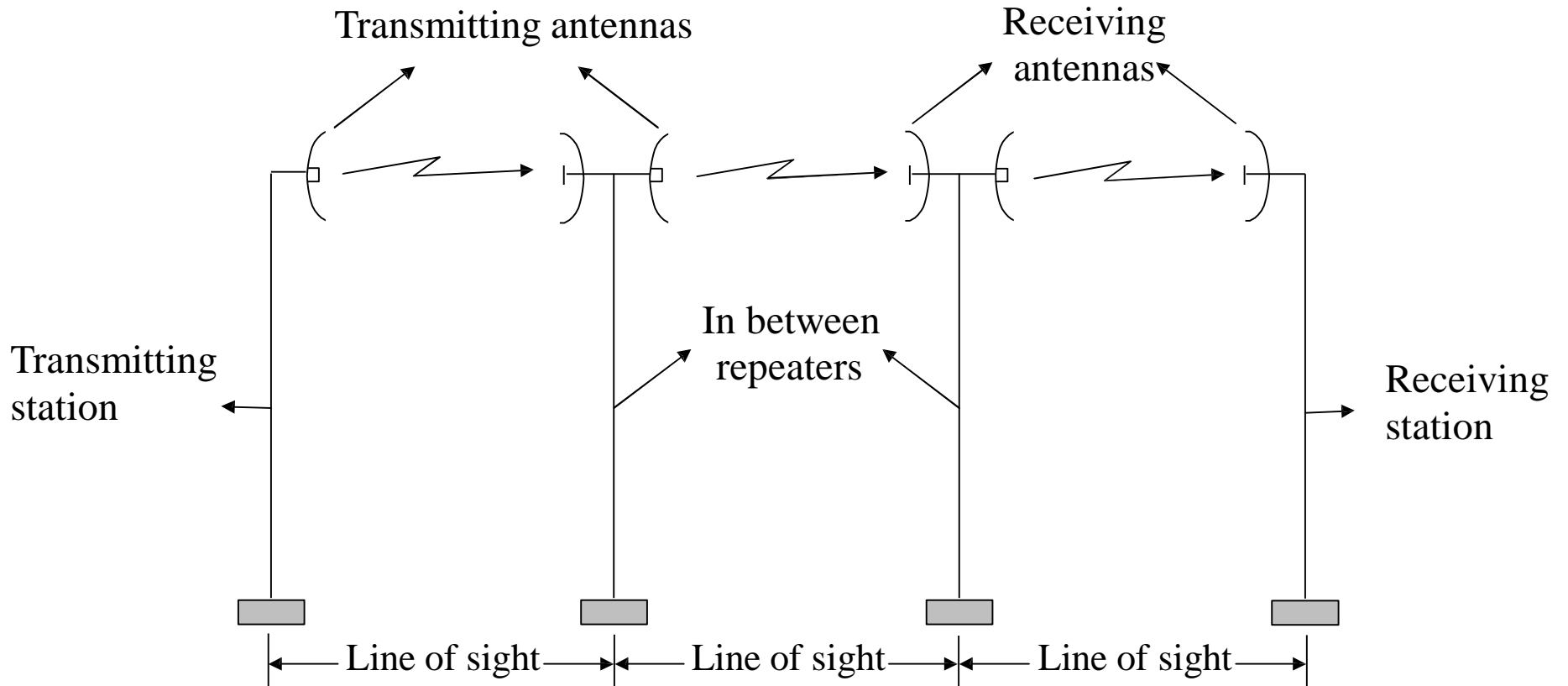

Satellite Communication System

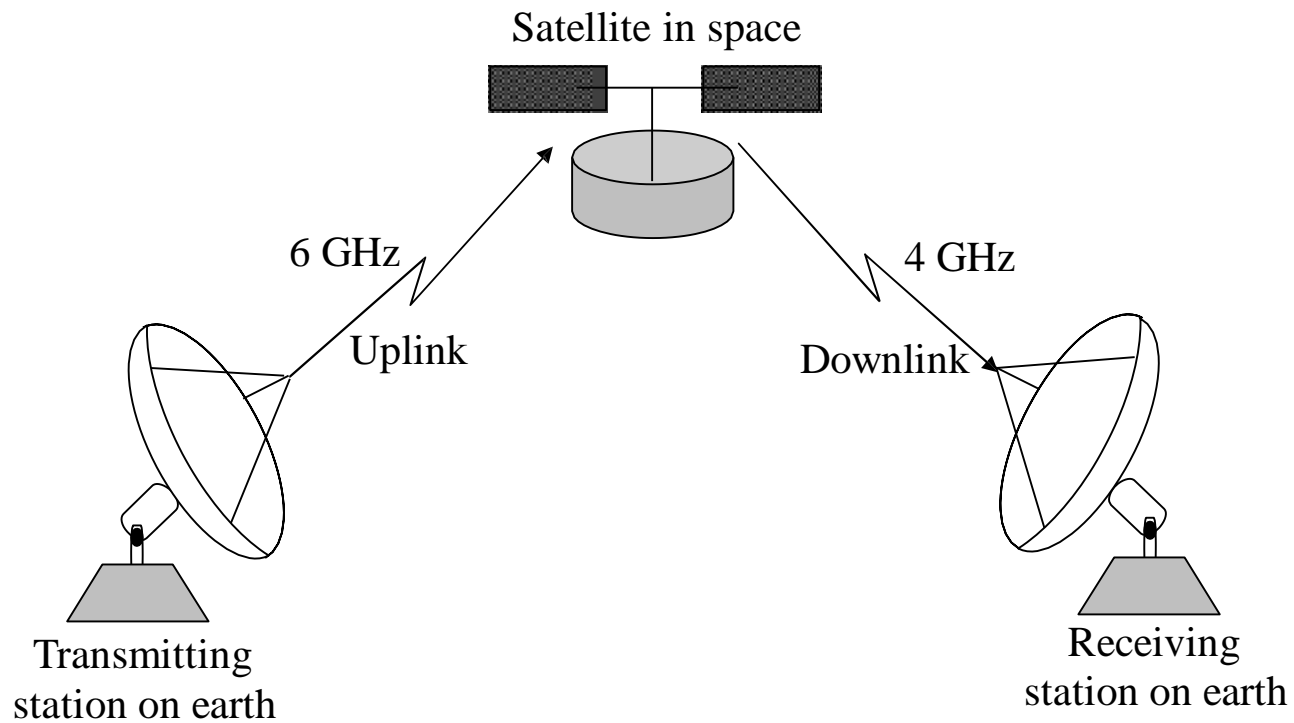

Optical Fiber Communication System

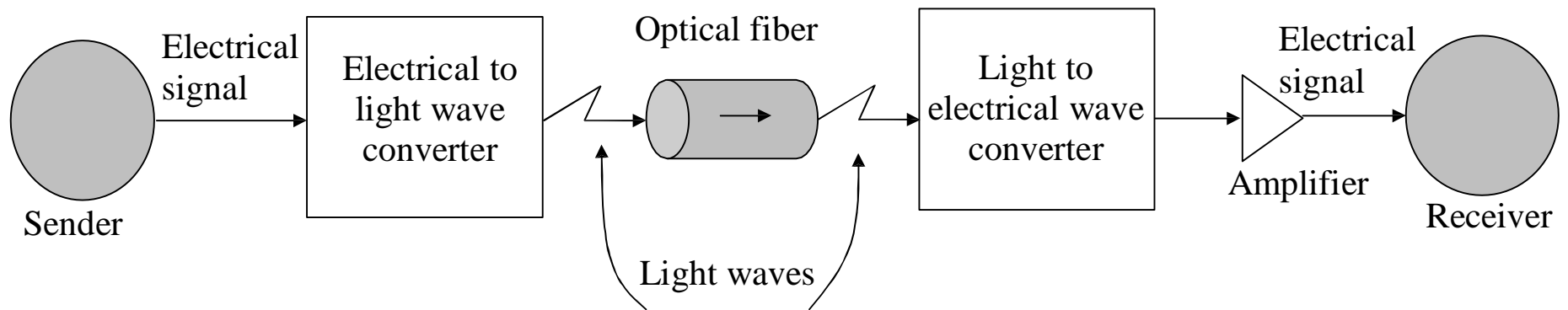

Digital and Analog Data Transmission

- *Analog signal*: Transmitted power varies over a continuous range. Example: sound, light, and radio waves
- *Digital signal*: Sequence of voltage pulses represented in binary form
- Computer generated data signal is digital, whereas telephone lines carry analog signals

(Continued on next slide)

Digital and Analog Data Transmission

(Continued from previous slide)

- When digital data is to be sent over an analog facility, digital signals must be converted to analog form
- Conversion of digital signal to analog form is known as modulation
- Conversion of analog signal to digital form is known as demodulation
- Digital transmission of data is preferred over analog transmission of data due to lower cost, higher transmission speeds, and lower error rate

Analog and Digital Signals

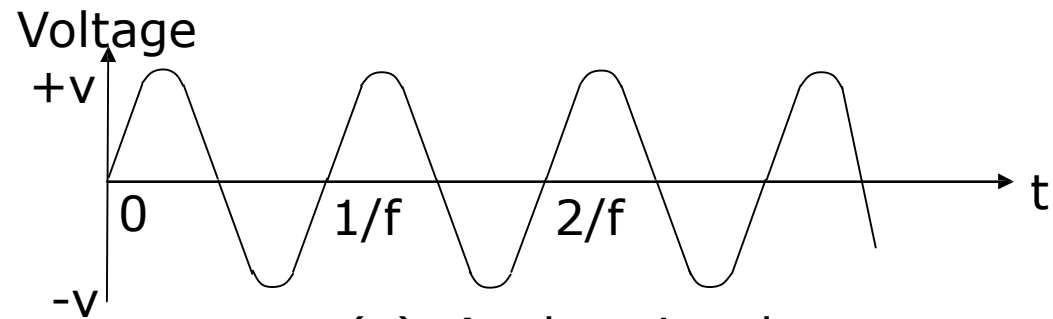

(a) Analog signal

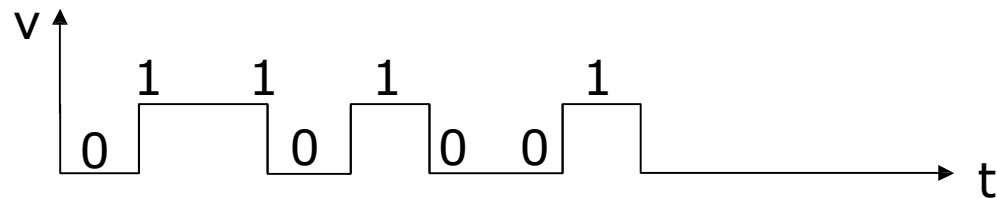

(b) Digital signal

Network Topologies

- Term *network topology* refers to the way in which the nodes of a network are linked together
- Although number network topologies are possible, four major ones are:
 - Star network
 - Ring network
 - Completely connected network
 - Multi-access bus network

Star Network

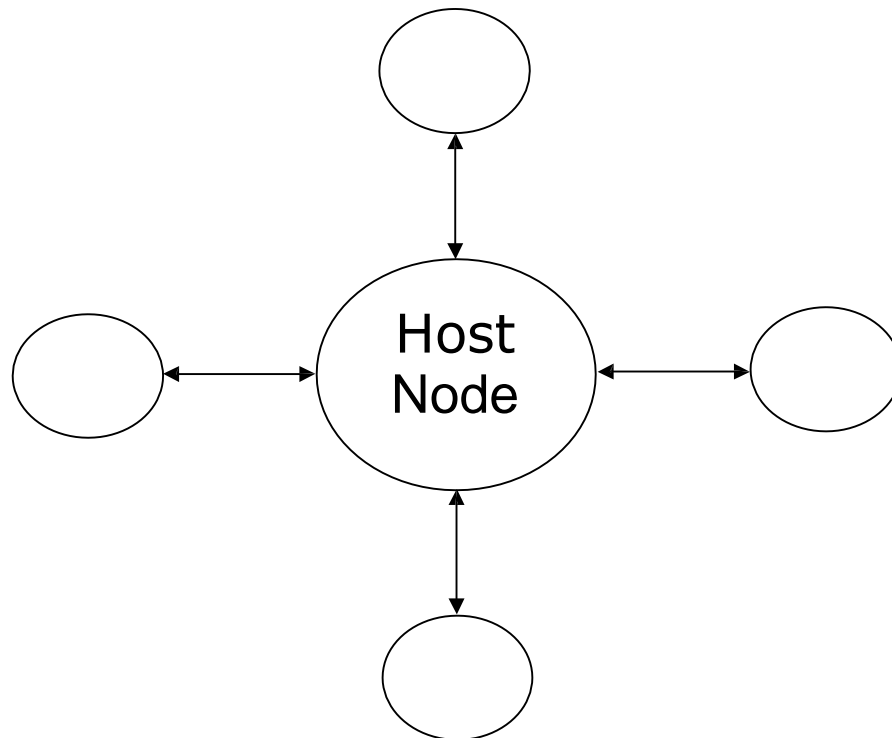

Ring Network

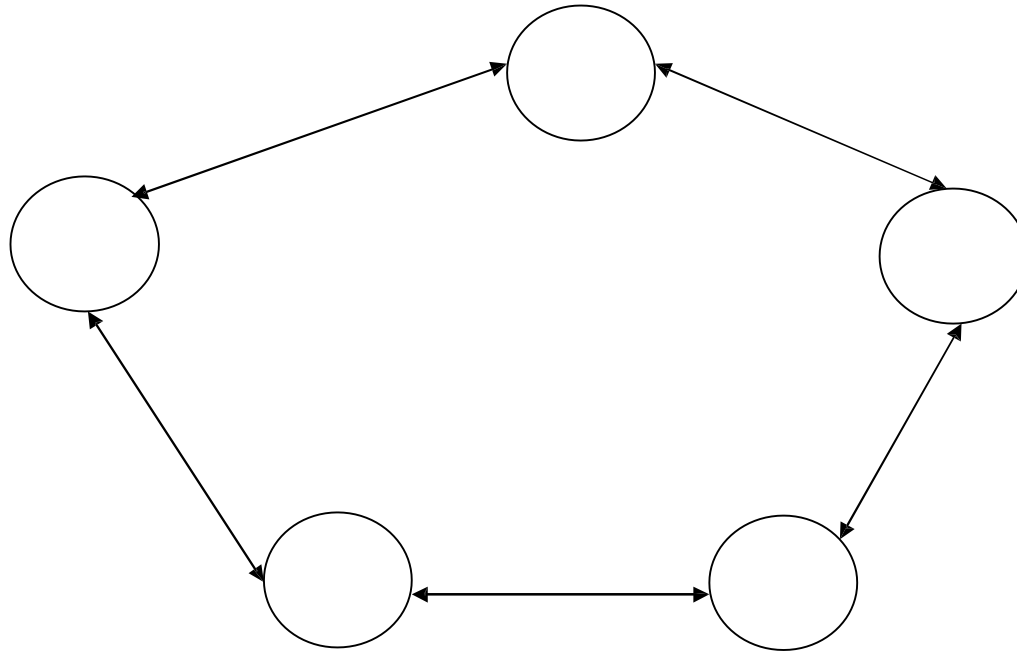

Completely Connected Network

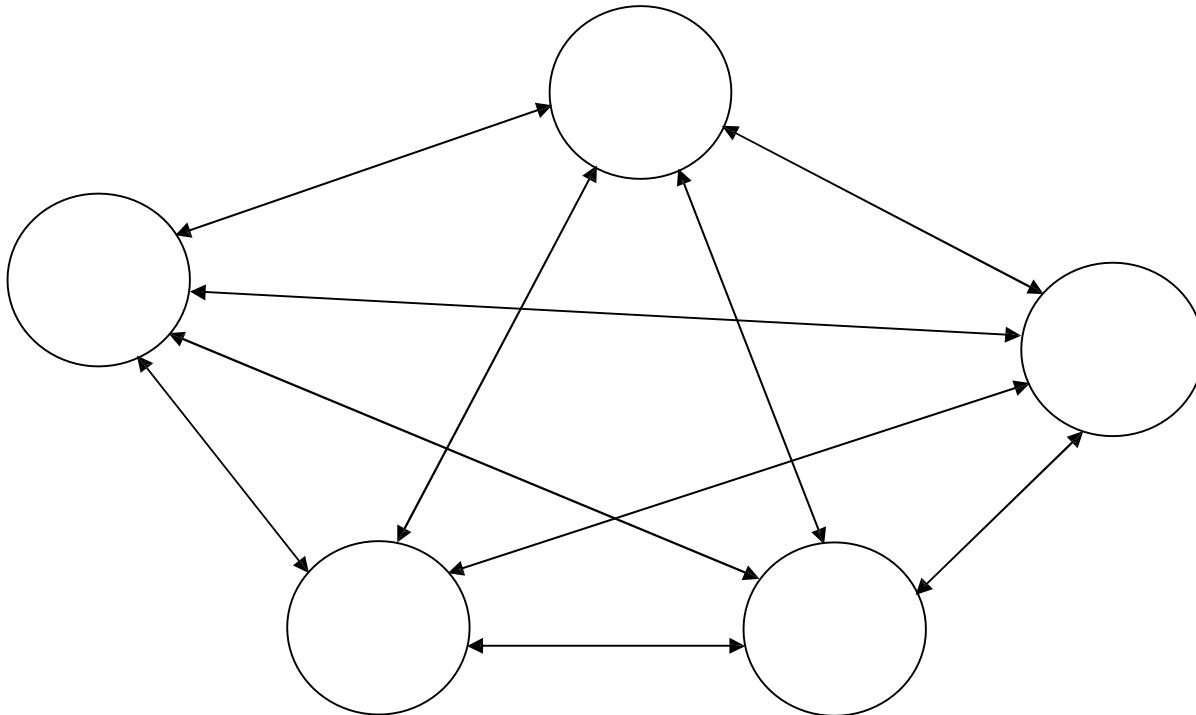

Multi-Access Bus Network

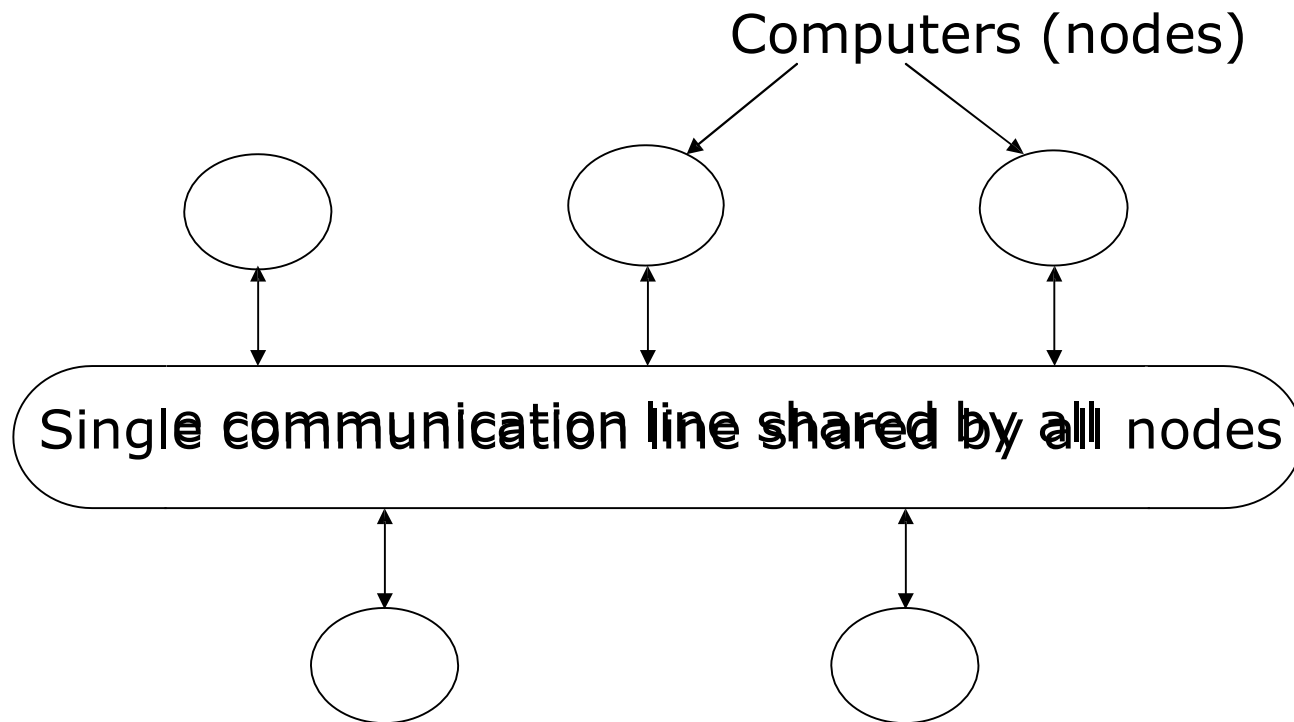

Hybrid Network

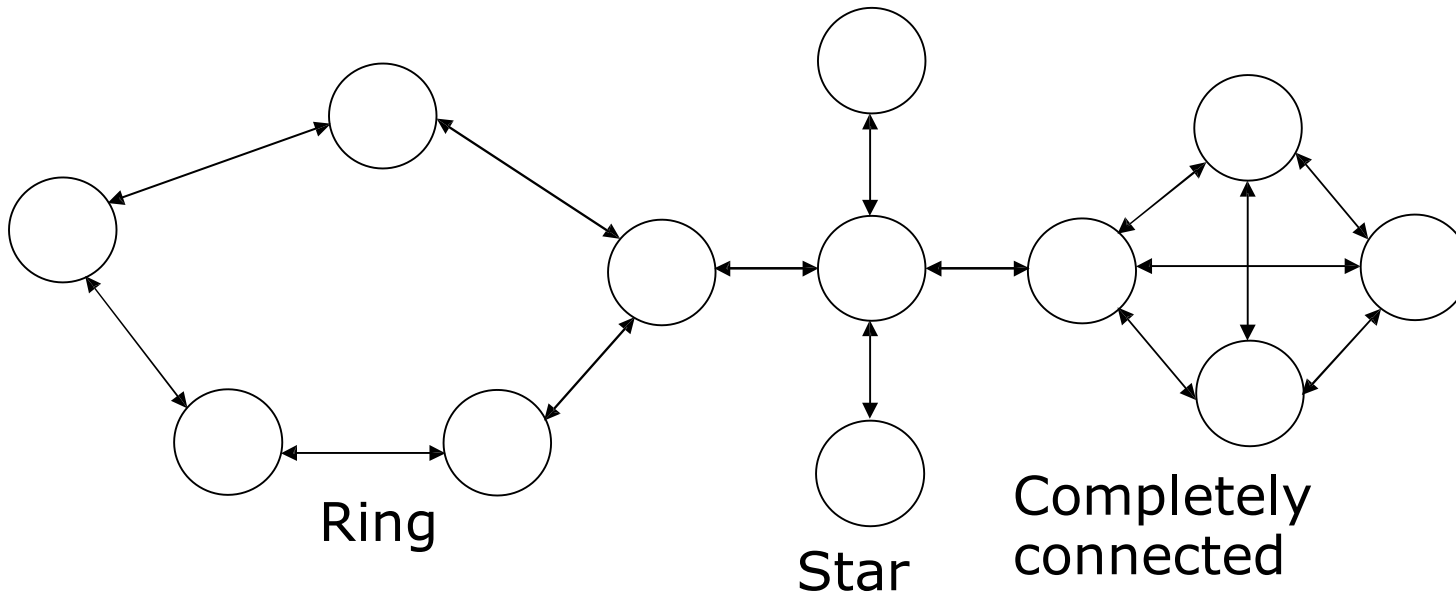

Network Types

- Networks are broadly classified into two types: Local Area Network (LAN) and Wide Area Network (WAN)
- Local Area Network (LAN) as compared to WAN:
 - Limited to a small geographic coverage
 - Has much higher data transmission rate
 - Experiences fewer data transmission errors
 - Has lower data communication cost
 - Typically owned by a single organization
- Networks that share some of the characteristics of both LANs and WANs are referred to as Metropolitan Area Network (MAN)

Communication Protocols

- Protocol is a set of formal operating rules, procedures, or conventions that govern a given process
- Communication protocol describes rules that govern transmission of data over communication networks
- Roles of communication protocol:
 - Data sequencing
 - Data routing
 - Data formatting
 - Flow control
 - Error control

(Continued on next slide)

Communication Protocols

(Continued from previous slide)

- Precedence and order of transmission
 - Connection establishment and termination
 - Data security
 - Log information.
- Communication protocols are normally split up into a series of modules logically composed of a succession of layers.
 - Terms *protocol suite*, *protocol family*, or *protocol stack* are used to refer to the collection of protocols (of all layers) of a network system

Network Interface Card (NIC)

- Hardware device that allows a computer to be connected to a network, both functionally and physically
- Printed circuit board installed on to one of the expansion slots of computer
- Provides a port on the back to which network cable is attached

The OSI Model

- The Open System Interconnection (OSI) model is framework for defining standards for linking heterogeneous computers in a packet switched network
- Standardized OSI protocol makes it possible for any two heterogeneous computer systems, located anywhere in the world, to easily communicate with each other
- Separate set of protocols is defined for each layer in its seven-layer architecture. Each layer has an independent function

Layers, Interfaces, and Protocols in the OSI Model

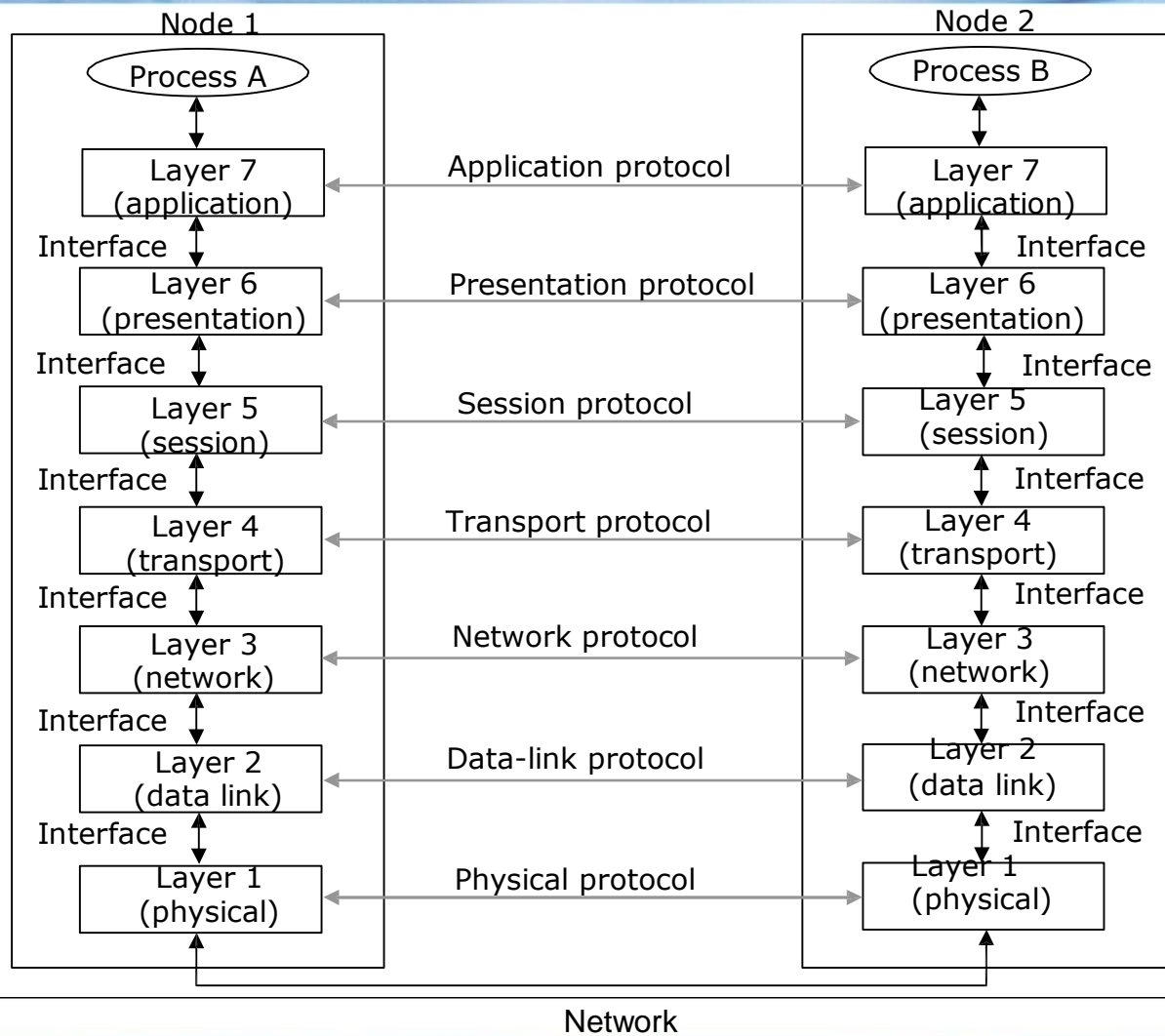

An example illustrating transfer of message M from sending node to the receiving node in the OSI model. Header added by layer n: H_n , trailer added by layer n.

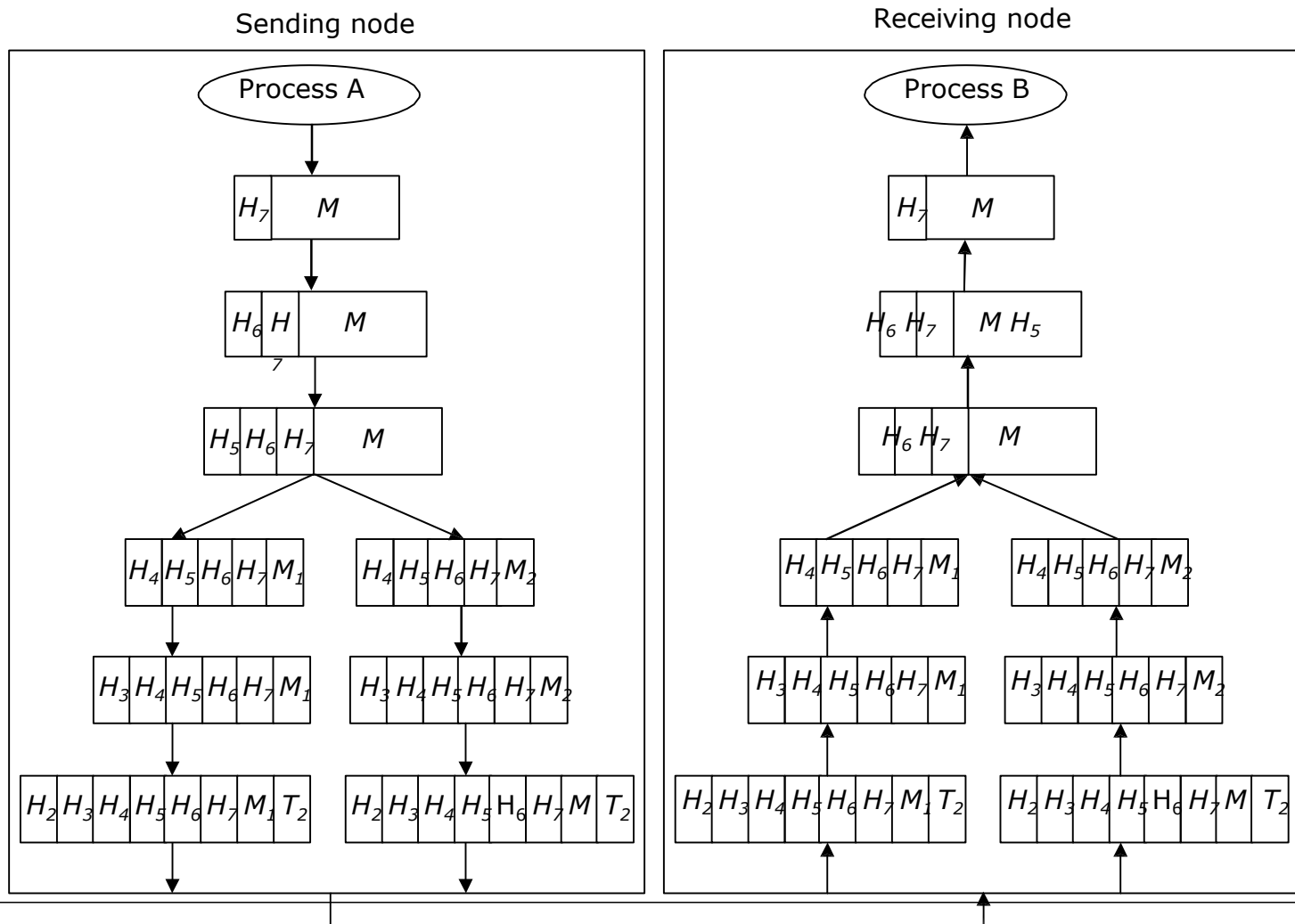

Internetworking

- Interconnecting two or more networks to form a single network is called *internetworking*, and the resulting network is called an *internetwork*
- Goal of internetworking is to hide details of different physical networks, so that resulting internetwork functions as a single coordinated unit
- Tools such as bridges, routers, brouters, and gateways are used for internetworking
- The Internet is the best example of an internetwork

Bridges

- Operate at bottom two layers of the OSI model
- Connect networks that use the same communication protocols above data-link layer but may use different protocols at physical and data-link layers

Routers

- Operates at network layer of the OSI model
- Used to interconnect those networks that use the same high-level protocols above network layer
- Smarter than bridges as they not only copy data from one network segment to another, but also choose the best route for the data by using routing table

Gateways

- Operates at the top three layers of the OSI model (session, presentation and application)
- Used for interconnecting dissimilar networks that use different communication protocols
- Since gateways interconnect dissimilar networks, protocol conversion is the major job performed by them

Wireless Computing Systems

- Wireless computing system uses wireless communication technologies for interconnecting computer systems
- Enhances functionality of computing equipment by freeing communication from location constraints of wired computing systems
- Wireless computing systems are of two types:
 - **Fixed wireless systems:** Support little or no mobility of the computing equipment associated with the wireless network
 - **Mobile wireless systems:** Support mobility of the computing equipment to access resources associated with the wireless network

Wireless Technologies

- 2G and 3G
- Wireless LAN
- WiMAX
- Wireless Local Loop (WLL)
- Radio-router
- Multihop Wireless Network
- Wireless Application Protocol (WAP)

Distributed Computing Systems

- Configuration where many independent computer systems are connected, and messages, processing task, programs, data, and other resources are transmitted between cooperating computer systems
- Such an arrangement enables sharing of many hardware and software resources as well as information among several users who may be sitting far away from each other

Main Advantages of Distributed Computing Systems

- Inherently distributed applications
- Information sharing among distributed users
- Resource sharing
- Shorter response times and higher throughput
- Higher reliability
- Extensibility and incremental growth
- Better flexibility in meeting users' needs